

GOLIATH GUILLOTINE PIPE SAW

Gary Herman Companies, LLC.
4706 Curtis Lane
New Iberia, LA 70560
337-367-2880 www.alpha4rentals.com

GOLIATH GUILLOTINE PIPE SAW 98-037

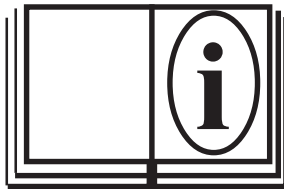

	TUBE & PIPE	CE
	CUT-OFF MACHINES	
Mod. Goliath Guillotine Ser.No. <input type="text"/> <input type="text"/> <input type="text"/> <input type="text"/> <input type="text"/>		
E.H. WACHS COMPANIES 100 Shepard St. Wheeling Il. 60090 Patent Pending		

Part Number: 98-037

Revision No: 2



Revised:
july '04

GOLIATH GUILLOTINE PIPE SAW

TABLE OF CONTENTS

I.	MACHINE SPECIFICATIONS.....	3
	1. Blade Recommendations.....	3
II.	MACHINE OPERATION.....	4-8
	1. Safety.....	5
	2. Set Up.....	5-6
	3. Blade Installation.....	6-7
	4. Operation.....	7
	5. Adjusting the Feed Rate.....	7
	6. Maintenance.....	8
III.	BILL OF MATERIALS.....	9-16
IV.	REORDER.....	17

GOLIATH GUILLOTINE PIPE SAW

SECTION I

MACHINE SPECIFICATIONS

The Wachs Goliath Guillotine Pipe Saw is shipped assembled except for the clamping chain and blade. The blade should be installed after the Guillotine is secured to the pipe. Please observe the warning sticker located on the Guillotine before proceeding to operate machine.

Capacity:	Cold cut all pipe material. 16" -32" (406-810 mm) diameter pipe
Wall thickness:	Any wall thickness
Clamping system:	Chain clamping
Feed system:	Hydraulic (Manual & automatic feed)
Feed rate:	0.008 or 0.016 (Adjustable)
Drive motor:	2 Heavy Duty Hydraulic Motor: 15 gpm @ 1500 psi (57 l/s @ 106 bar)
Finish:	Paint, epoxy, stainless, utilization of anti-corrosive process on other parts.
Weight:	1800 lbs.

Blade Recommendations:

PN	Description
93-37-414	Coarse blade used for heavy wall or multi-strand pipe.
93-37-415	Fine blade used for thin wall single strand pipe.

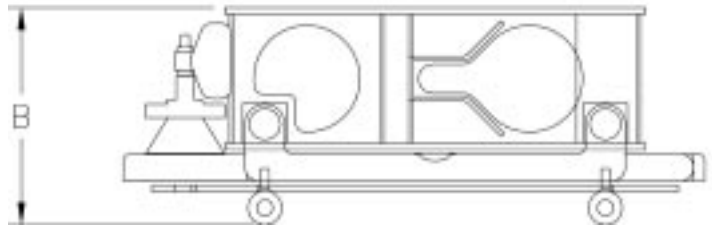

Dimensions

A- 66"

B- 25"

C- 76-1/2"

D- 33"

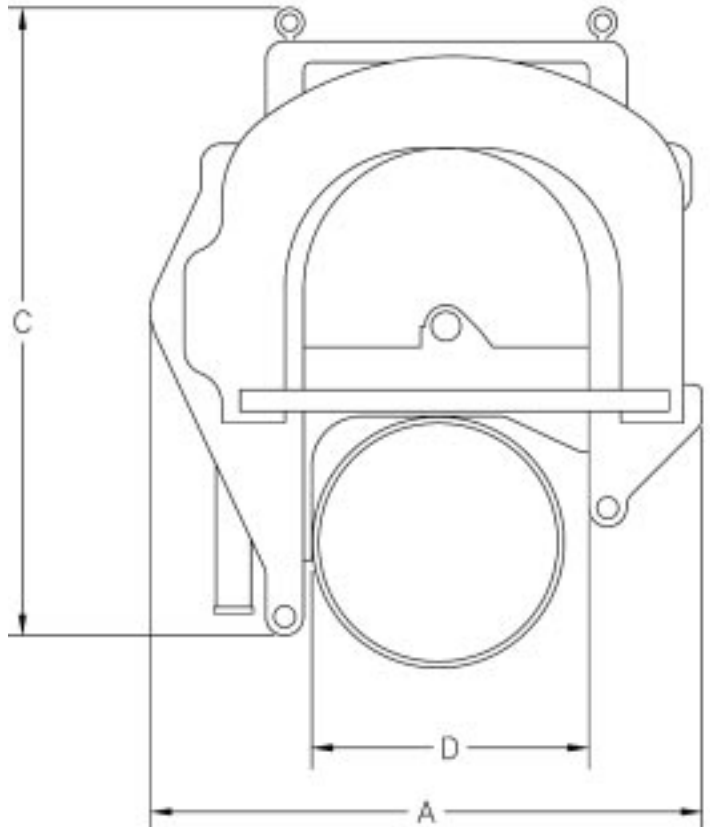

MACHINE OPERATION

GOLIATH GUILLOTINE PIPE SAW

SECTION II

SAFETY & MACHINE OPERATION

Safety

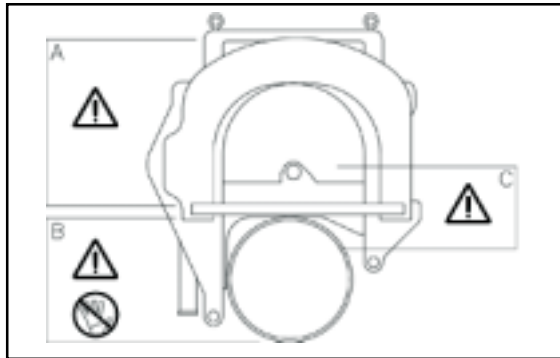

Unsafe Operation Zones

The above diagram illustrates zones that should be avoided by the user during operation:

- A. **CAUTION-** Oscillating Saw Bow
- B. **CAUTION-** Pipe Saddle, keep hands and feet clear when resting saw on pipe.
- C. **CAUTION-** Cutting zone, keep all body parts clear during operation.

NOTE: GREASE MACHINE BEFORE EVERY CUT
(see maintenance section).

1. Before proceeding to install the Guillotine, make sure that the blade is raised as high as possible by turning the feed handle clock-wise until it tops out. Make sure that the feed control lever is locked in the neutral (disengaged) position. This is done by pushing the feed lock out pin **A** towards the machine, while forcing the feed control lever **B** down (figure 1).
2. Attach water hose to the chip remover, and adjust the chip remover so that the water steam flows over the teeth of the blade. Adequate water flow is necessary to extend blade life and prevent sudden blade failures.

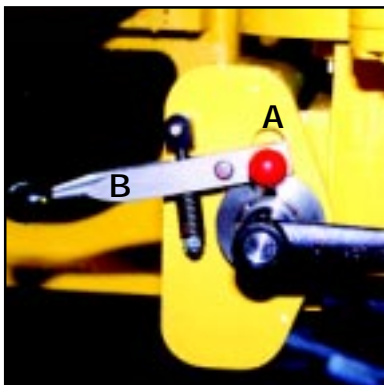

figure 1

3. The clamping chain is attached to the saddle by inserting the supplied $\frac{1}{2}$ "x $\frac{1}{2}$ " shoulder screw into the saddle and chain assembly.
4. Lift saw on to the pipe with the supplied lift the Guillotine on the pipe using eyebolts **F** and **E** (figure 2) to mount the machine vertically.

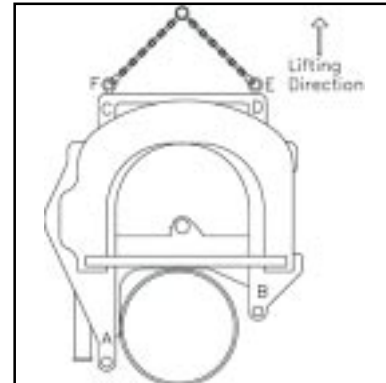

figure 2

The machine will also mount onto a horizontal pipe on its side, use eyebolts **F** and **G** (figure 3).

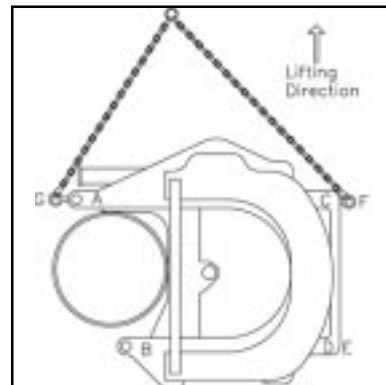

figure 3

When the pipe is vertical use eyebolts **A**, **C** and **D** (figure 4). The pipe rests against the saddle as illustrated (figure 2).

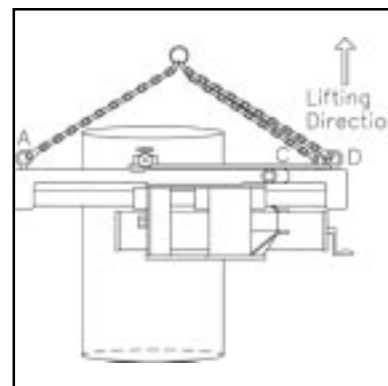

figure 4

GOLIATH GUILLOTINE PIPE SAW

SECTION II

MACHINE OPERATION



figure 5

5. Once the Guillotine is in the desired position, wrap the clamping chain around the pipe belly. Pull the chain tight, engaging the closest cross pin all the way into the clamp screw hook (figure 5).
6. Tighten the clamping nut clock-wise until the machine is solid to the pipe (figure 6).



figure 6

7. Remove the frame leg support after the machine is mounted, by turning it counter-clock-wise. **This leg is for stabilizing the machine while it is being mounted not necessary for operation. The leg will interfere with operation if left in, and may damage machine.**

CAUTION: Do not remove the chain and lifting devise from the machine. Allow the lifting chain to go slack during operation. This is for safety. Failure to do this may cause damage to the operator or the machine.

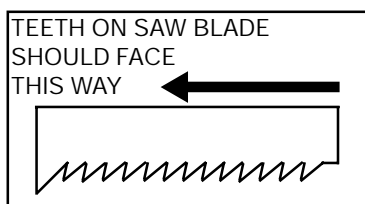

figure 7

Blade Installation

Caution: Use gloves to remove worn blades. Metal fragments may cut bare hands.

1. Bring frame bow into its outermost position by turning the feed handle counter-clock-wise.



figure 10



figure 9

2. Loosen the tension knob and the two blade clamp knobs counterclockwise.
3. Check blade to make sure that the cutting edge of the teeth point left when you face the front of the machine (see decal, figure 7). The blade is mounted to the lowest dowel pin located at the end of the bow. To tension the blade, tighten the two blade clamp knobs, hand tight. Tighten the tension knob until taut (figure 8). Then tighten the blade clamp knobs, left side and right side of the bow (figure 9).

GOLIATH GUILLOTINE PIPE SAW

SECTION II

MACHINE OPERATION

A sharp taut blade will assure a straight, clean cut.



figure 10

4. When the cut has completed, turn off power before raising the blade. The blade may have to be removed if binding occurs.

Operation:

Caution: Make sure that there is slack in the lifting device at all times during operation.

1. Close the hydraulic valve (figure 10).
2. Adjust the feed control by pushing the feed control lever **A** down and push in the feed lockout pin **B**, to disengage the automatic feed.
3. Turn on the power supply. Adjust the power unit to 15 GPM.
4. Slowly open the hydraulic valve until it is fully opened (figure 10).
5. To engage the cut, release the feed control lever by pulling the feed lock out of pin out (figure 11).

Adjusting the Feed Rate

There is one fixed feed trip pin located on the wheel cam. As the wheel cam rotates, the feed trip pin strikes the feed shaft, causing the worm feed gear to rotate. As the worm feed gear rotates, the bow feeds into the cut.

The feed rate has been factory set at approximately 0.008" per cycle.

The feed rate can be doubled by sliding out the second feed trip pin (figure 12).

1. Slide out the feed trip pin about ½ inch, to engage second feed trip pin. It will lock in place.
2. To restore factory feed rate, push feed trip pin back to its original place.

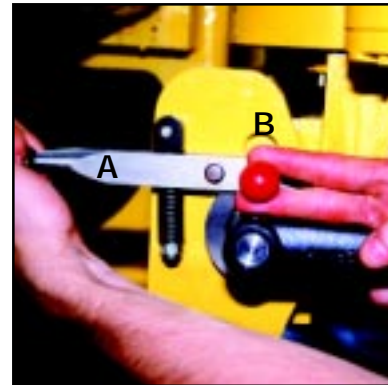

figure 11

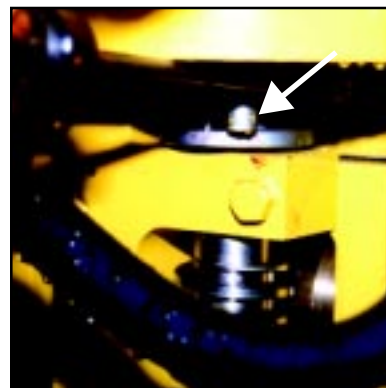

figure 12

GOLIATH GUILLOTINE PIPE SAW

SECTION II

MAINTENANCE

Maintenance

There are four (4) grease fittings (figure 13).

Wipe shafts and feed tower ways to remove unwanted particles and grease after each cut (figure 14).



figure 13

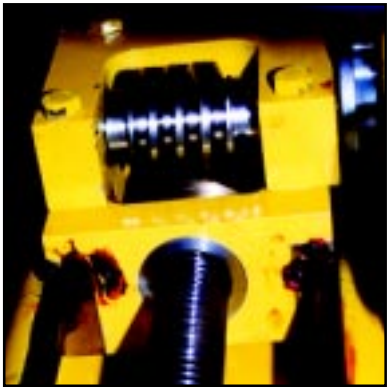

figure 14

BILL OF MATERIALS

GOLIATH GUILLOTINE PIPE SAW

SECTION III



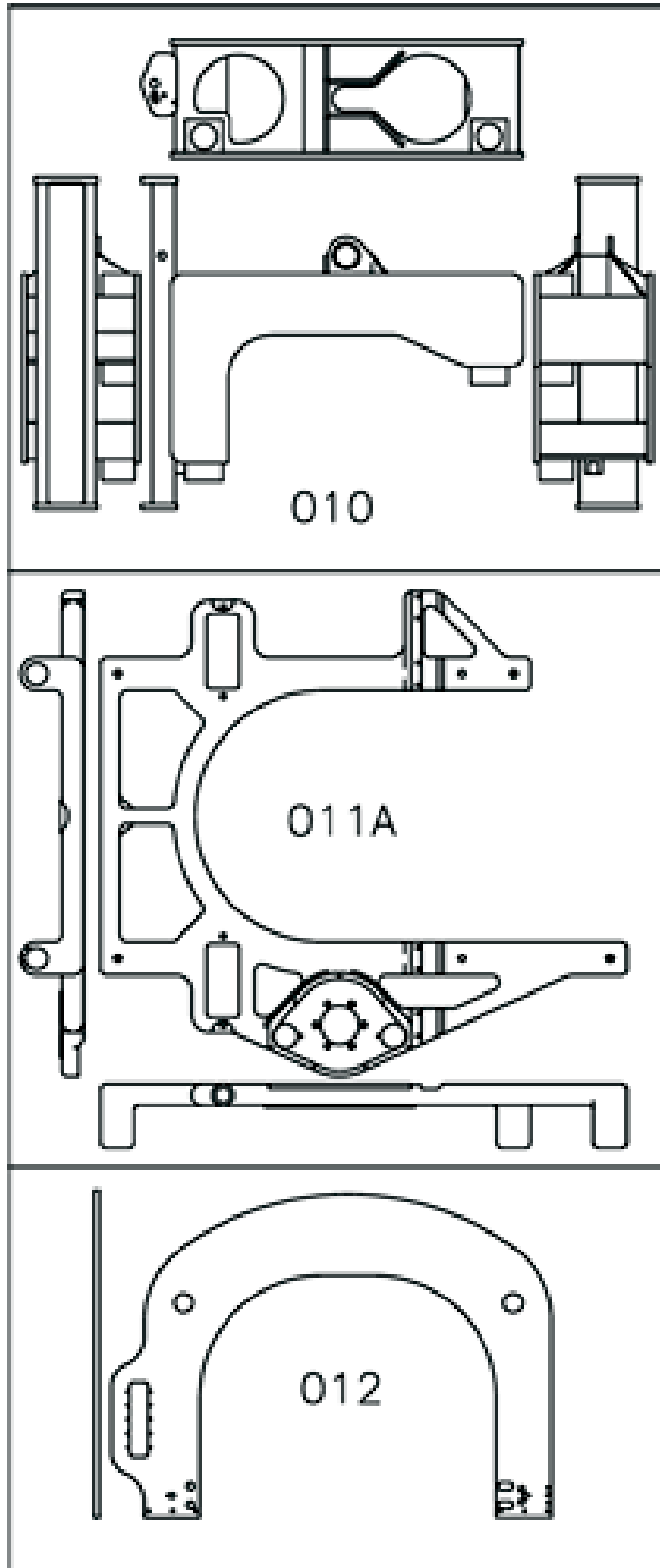







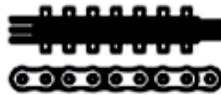

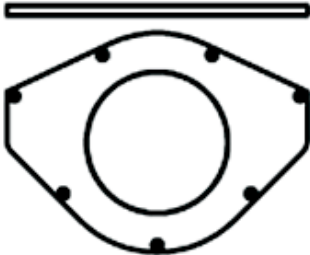



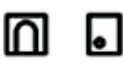

BILL OF MATERIALS

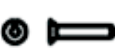

GOLIATH GUILLOTINE PIPE SAW

SECTION III











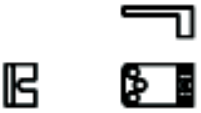



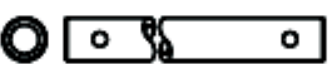

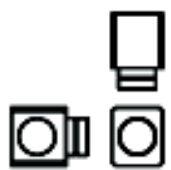

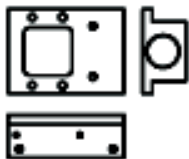
BILL OF MATERIALS

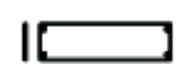
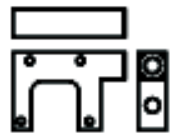
001		031	
002		032	
003		033	
004		034	
005		035	
006		036	
013		037	
014		038	
015		039	
016		040	

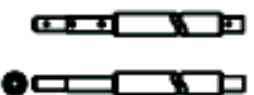
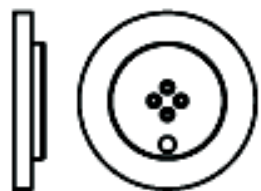
GOLIATH GUILLOTINE PIPE SAW

SECTION III

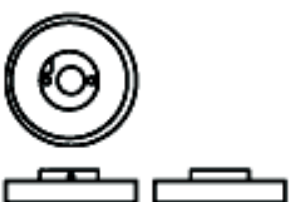
BILL OF MATERIALS

017		B41	
020		042	
021		043	
023		B44	
024		045	
025		B46	
026		047	
027		B48	
028		049	
029		050	
B30		056	
		058	

GOLIATH GUILLOTINE PIPE SAW

SECTION III

BILL OF MATERIALS

MANUFACTURED PARTS

Qty.	Parts Description	Ref. #	Associated Parts
1	98-037-001	001	CLAMPING CHAIN
1	98-037-002	002	HOOK, CLAMP SCREW
1	98-037-003	003	SCREW, CLAMP
1	98-037-004	004	NUT, CLAMP
1	98-037-005	005	PIN, CLAMP SCREW
1	98-037-006	006	MOUNT, CHAIN
1	98-037-010	010	WELDMENT - FRAME, VISE
1	98-037-011A	11A	FRAME, MAIN
1	98-037-012	012	FRAME, BOW
1	98-037-013	013	CLAMP, BLADE PULL
2	98-037-014	014	BOLT, BLADE CLAMP
1	98-037-015	015	KNOB, BLADE TENSION
1	98-037-016	016	CLAMP, BLADE TENSION
1	98-037-017	017	GUIDE, TENSION CLAMP
1	98-037-020	020	SHAFT-S, FRAME GUIDE
1	98-037-021	021	SHAFT-L, FRAME GUIDE
2	98-037-023	023	BLOCK, BOW SLIDE
2	98-037-024	024	SHAFT, BOW SLIDE
1	98-037-025	025	YOKE, BOW FEED
1	98-037-026	026	COVER, FEED YOKE
1	98-037-027	027	SHAFT, GEAR
1	98-037-028	028	GEAR
2	98-037-029	029	GEAR, PINION
1	98-037-B30	B30	WHEEL, CAM
1	98-037-031	031	HOUSING, GEAR SHAFT
1	98-037-032	032	COVER, GEAR
1	98-037-033	033	LEG, FRAME SUPPORT
2	98-037-034	034	LUG, LIFTING
1	98-037-035	035	LEVER, FEED CONTROL
1	98-037-036	036	PIN, FEED LOCK-OUT
1	98-037-037	037	CAM, FEED OVERLOAD
1	98-037-038	038	RETAINER, FEED SCREW

GOLIATH GUILLOTINE PIPE SAW

SECTION III

BILL OF MATERIALS

MANUFACTURED PARTS

Qty.	Parts Description	Ref. #	Associated Parts
1	98-037-039	039	BUSHING, FEED SCREW
1	98-037-040	040	WORM, FEED
1	98-037-B41	B41	GEAR, WORM FEED
2	98-037-042	042	RETAINER, WORM GEAR
1	98-037-043	043	PIN, FEED TRIP
1	98-037-B44	B44	SHAFT, FEED
1	98-037-045	045	HOUSING, FEED SLIDE
2	98-037-B46	B46	GIB, FEMALE FEED
1	98-037-047	047	MOUNT, FEED SHAFT
1	98-037-B48	B48	SCREW, FEED
2	98-037-049	049	PLATE, MALE GUIDE
2	98-037-050	050	GUIDE, BOW - FEMALE
1	98-037-056	056	SPACER, CAM FOLLOWER - BOW
1	98-037-057	N/S	STICKER, LIFTING HARNESS
4	98-037-058	058	BUSHING, GUIDE ROD
2	98-037-059	N/S	KNOB, BLADE CLAMP
1	04-045-00	N/S	HANDLE, FEED (MODEL "D")
2	97-009-07	N/S	RETAINER, PINION GEAR
1	98-037-60	N/S	CHAIN SPACER
1	98-037-61	N/S	CHIP REMOVER
3			1/4" DIA X 2" LONG BRASS TUBING BENT AT 45 DEG
1	98-037-65	N/S	STICKER, LUBRICATION
	98-037-414	N/S	BLADE, 32" GUILLOTINE 2/3 PITCH
	98-037-415	N/S	BLADE, 32" GUILLOTINE 3/4 PITCH
	*N/S= Not Shown		

GOLIATH GUILLOTINE PIPE SAW

SECTION III

BILL OF MATERIALS

PURCHASED PARTS

Qty.	Parts Description	Associated Parts
2	MOTOR, 146cm/r x 1"Shaft x 7/8-14Port x 2Blt	MAIN FRAME
1	BEARING, 7/8" x 1" x 1" LG. SLEEVE	WORM SHAFT
1	BEARING, 7/8" x 1" x 1-1/2" LG. SLEEVE	WORM SHAFT
1	BEARING, 1" x 1-1/8" x 3/4" LG. SLEEVE	FEED SCREW
4	BEARING, 2" x 2-3/16" x 1-1/2" LG. SLEEVE	BOW FRAME
2	BEARING, .875 x 1.5 x .0585 THK. THRUST	WORM
2	BEARING, 1.0 x 1.75 x .0585 THK. THRUST	FEED SCREW
1	BEARING, 1.9685 x 3.5433 BALL	GEAR SHAFT
1	BEARING, 2.3622 x 4.3307 BALL	GEAR SHAFT
2	BEARING, 2.0 x 1.25 x 1-1/8-12 THD. CAM	CAM WHEEL/YOKE
1	SEAL, 8.0 x 9.0 x .625	FINAL GEAR
1	SEAL, 1.938 x 3.543 x .313	GEAR SHAFT
2	NUT, 5/8 W. x 2.548-18 THD. LOCK	BOW SLIDE BLK'S
1	RING, 3.0 x .061 EXTERNAL RETAINING	CLAMP SCREW PIN
1	RING, 3.543 x .061 INTERNAL RETAINING	GEAR SHAFT
1	RING, 1.969 x .062 EXTERNAL RETAINING	GEAR SHAFT
1	RING, 2.375 x .078 EXTERNAL RETAINING	GEAR SHAFT
4	O-RING 3-1/4 ID x 3/32 STD.	HYD. MOT/CAM WHEEL
1	O-RING 3-3/4 ID x 1/8 STD.	FINAL GEAR
1	O-RING 7-1/2 ID x 1/8 STD.	GEAR SHAFT HOUS.
1	SPRING, .60 OD x 2.500 LG. x .085	FEED CLUTCH
1	SPRING, .60 OD x 2.250 LG. x .085	FEED CLUTCH
1	SPRING, .70 OD x 2.0 LG. x (5/32x3/32)	FEED CLUTCH
1	SWING-BOLT, 3/8-16 x 3-1/2 LG.	FEED CLUTCH
6	EYE-BOLT, 1"-8 THD. X 1-3/4 ID	MAIN FRAME
1	KNOB, 1-1/8 x 1-7/16 x 3/8-16 THD. BLACK	FEED CLUTCH LEV.
1	KNOB, 1" x 1/4-20 THD. BLACK.	FEED CLUTCH PIN
2	KNOB, BLADE CLAMP	BLADE CLAMP
1	KNOB, BLADE TENSIONER	BLADE TENSIONER
2	LOCKNUT, CLAMP SCREW	CLAMP SCREW
5	FITTING, 1/4-28 MALE GREASE (STRAIGHT)	FEED SHAFT MOUNT
1	CHAIN, CLAMP	98-037-001
1	FITTING, 90 DEG. 3/4-14 NPT (M) x 1 1/16-12 JIC (M)	MOTOR
1	FITTING, TEE-MALE 3/4-14 NPT (M) x (M) x (M)	MOTOR
2	FITTING, STR. 7/8-14 ORB (M) x 3/4-14 NPT (F)	MOTOR
2	FITTING, STR. 1 1/16-12 JIC (M) x 7/8-14 ORB (M)	MOTOR
2	FITTING, SWIVEL 90 DEG. 1 1/16-12 JIC (M) x (F)	MOTOR
1	FITTING, TEE-MALE 3/4-14 NPT (M) x (M) x 1 1/16-12 JIC (M)	MOTOR
1	HIGH PRESSURE BALL VALVE 3/4 NPT	MOTOR
1	HOSE, 3/4" H.P. HYD. -12 JIC (F) x (F) x 17" OA LG.	MOTOR
1	HOSE, 3/4" H.P. HYD. -12 JIC (F) x (F) x 30" OA LG.	BY-PASS
1	90 DEG STREET ELBOW 3/8" PIPE SIZE	METAL REMOVAL
4"	GALVANIZED PIPE 3/8" X 3" LONG	METAL REMOVAL
2	EYE-BOLT, 1/2-13 X 1-3/16 LG" ID	BLADE CLAMP
1	OBLONG SLING LINK 1/2" STOCK DIAMETER	SLING
5	ANCHOR SHACKLES 3/8" STOCK Diameter	SLING
1	FLAT PROFILE GRAB HOOKS 5/16" CHAIN SIZE	SLING
15ft	Chain 5/16"	SLING

GOLIATH GUILLOTINE PIPE SAW

SECTION III

BILL OF MATERIALS

FASTNERS

Qty.	Parts Description	Associated Parts
4	SHOULDER SCREW, 1" x 4" LG.	SHAFT MOUNT BLK.
1	SHOULDER SCREW, 1/2 x 2-1/2" LG.	CHAIN MOUNT
2	PIN, 1/4 x 5/8 LG DOWEL	BOLT CLAMP
4	PIN, 5/16" x 1-1/4" LG. DOWEL	WORM GEAR RETAINER
3	PIN, 5/16" x 1-1/2" LG. DOWEL	FEED WORM/FEED CAM/SCREW RET.
3	PIN, 3/8" x 1-1/2" LG. DOWEL	1-SPRING/2-CAM WHEEL
1	PIN, 1/2" x 1" LG. DOWEL	FINAL GEAR
4	PIN, 1/2" x 1-1/4" LG. DOWEL	1-CAM/2-SLIDE/1-TENSIONER
1	PIN, 1/2 x 1-1/2" LG. DOWEL	CLAMP SCREW
1	PIN, 1/2" x 1-3/4" LG. DOWEL	FEED CONTROL LEVER
1	PIN, 3/4" x 3" LG. DOWEL	CHAIN HOOK
2	PIN, 3/4" x 1" LG. DOWEL	GUIDE, BLADE MOUNT
2	PIN, 1" x 2" LG DOWEL	BLADE CLAMP
2	PIN, 1" x 2-1/2" LG DOWEL	BLADE CLAMP
1	PIN, 3/16" x 1-1/4" LG. ROLL	FEED TRIP PIN
2	PIN, 1/4" x 1-1/2" LG. ROLL	FEED SCREW
4	PIN, 3/4" x 3" LG. ROLL	BOW SLIDE SHAFTS
2	SHCS, 3/8-16 x 2-1/4" LG.	TENSION MOUNT
6	SHCS, 1/2-13 x 1-1/4" LG.	DRIVE HOUSING
4	SHCS, 1/2-13 x 1-1/2" LG.	HYD. MOTORS
4	SHCS, 1/2-20 x 1-1/4" LG.	FINAL GEAR
2	FHCS, 1/4-20 x 7/8" LG.	HYD. MOTORS
7	FHCS, 5/16-18 x 1-1/4" LG.	GEAR COVER
8	FHCS, 1/2-13 x 1-1/2" LG.	MALE GUIDE PLATE
4	FHCS-SS, 1/2-20 x 1-1/2" LG.	FEMALE FEED GIB
6	FHCS, 1/2-13 x 1-3/4	FEMALE BLADE GUIDES
2	FHCS-SS, 3/4-10 x 4" LG.	BLADE CLAMP
1	SSS, 3/8-16 x 1-1/4" LG.	FEED CONTROL LEVER
1	SSS, 1"-8 x 4" LG.	FRAME SUPPORT LEG
10	HHCS, 3/8-16 x 1-1/4	BLADE YOKE
4	HHCS-SS, 1/2-20 x 2-1/2" LG.	FEED SLIDE
2	HHCS-SS, 3/4-16 x 3-1/2" LG.	BLADE TENSIONER
4	BHCS, 10-24 x 3/8	BLADE YOKE COVER
1	NUT, 3/8-16 NYLOCK	CHAIN MOUNT
1	WASHER, 1/4" STD.	FEED SPRING
1	1"-8 STAINLESS STEEL HEX HEAD	CHIP REMOVER

GOLIATH GUILLOTINE PIPE SAW

SECTION IV

REORDER

To place an order or to get more detailed information on any E.H. Wachs products, call us at:
1-800-323-8185.

ORDERING REPLACEMENT PARTS

Please use parts list provided in manual. Have part description and part number of required replacement part or parts to help expedite order and insure proper parts are being ordered.

REPAIR INFORMATION

Please call E.H. Wachs Company prior to returning any equipment for repair. We will advise you of shipping and handling. Please enclose with equipment to be repaired your name, address, phone number and a brief description of problem or work to be done or estimated.

All repair work done at our plant will be estimated and the customer advised of cost and time required to complete repair.

WARRANTY INFORMATION

Enclosed with the manual is a warranty card. Please fill out the registration card and return to E.H. Wachs. Retain the owners registration record and warranty card for your information.

RETURN GOODS ADDRESS

E.H. Wachs Company
100 Shepard Street
Wheeling, Illinois 60090

Gary Herman Companies, LLC.
4706 Curtis Lane
New Iberia, LA 70560
337-367-2880 www.alpha4rentals.com

847-537-8800

FAX: 847-520-1147 • 847-520-1168

Toll-Free: 1-800-323-8185

WWW.WACHSCO.COM



TUBE & PIPE

CUT-OFF MACHINES



Mod. Goliath Guillotine Ser. No.

<input type="text"/>	<input type="text"/>	<input type="text"/>	<input type="text"/>	<input type="text"/>	<input type="text"/>	<input type="text"/>
----------------------	----------------------	----------------------	----------------------	----------------------	----------------------	----------------------